

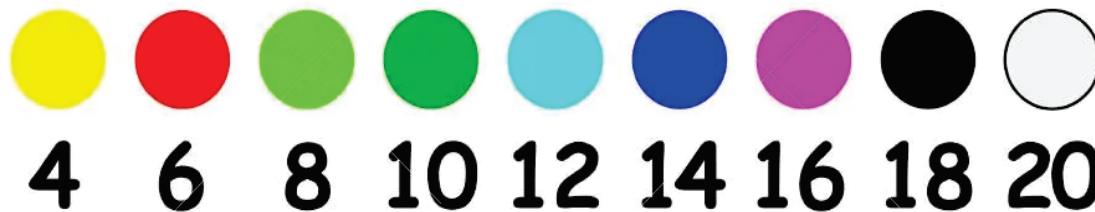

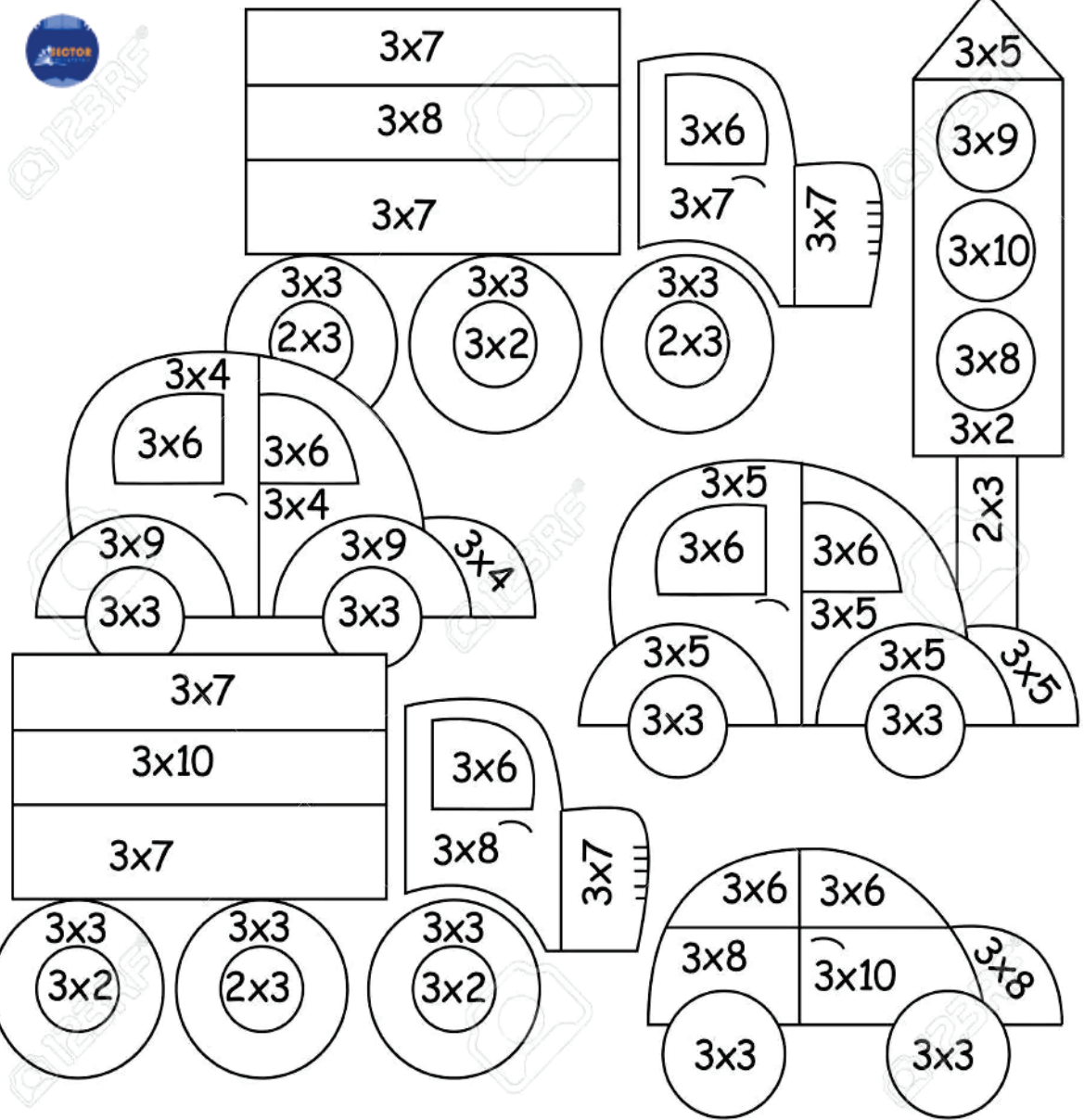

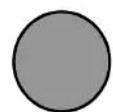



- $2 \times 1 = 2$
- $2 \times 2 = 4$
- $2 \times 3 = 6$
- $2 \times 4 = 8$
- $2 \times 5 = 10$
- $2 \times 6 = 12$
- $2 \times 7 = 14$
- $2 \times 8 = 16$
- $2 \times 9 = 18$
- $2 \times 10 = 20$
- $2 \times 11 = 22$
- $2 \times 12 = 24$





- 3X1=3**
- 3X2=6**
- 3X3=9**
- 3X4=12**
- 3x5=15**
- 3X6=18**
- 3X7=21**
- 3x8=24**
- 3X9=27**
- 3X10=30**
- 3X11=33**
- 3X12=36**

-  **6**
-  **9**
-  **12**
-  **15**
-  **18**
-  **21**
-  **24**
-  **27**
-  **30**

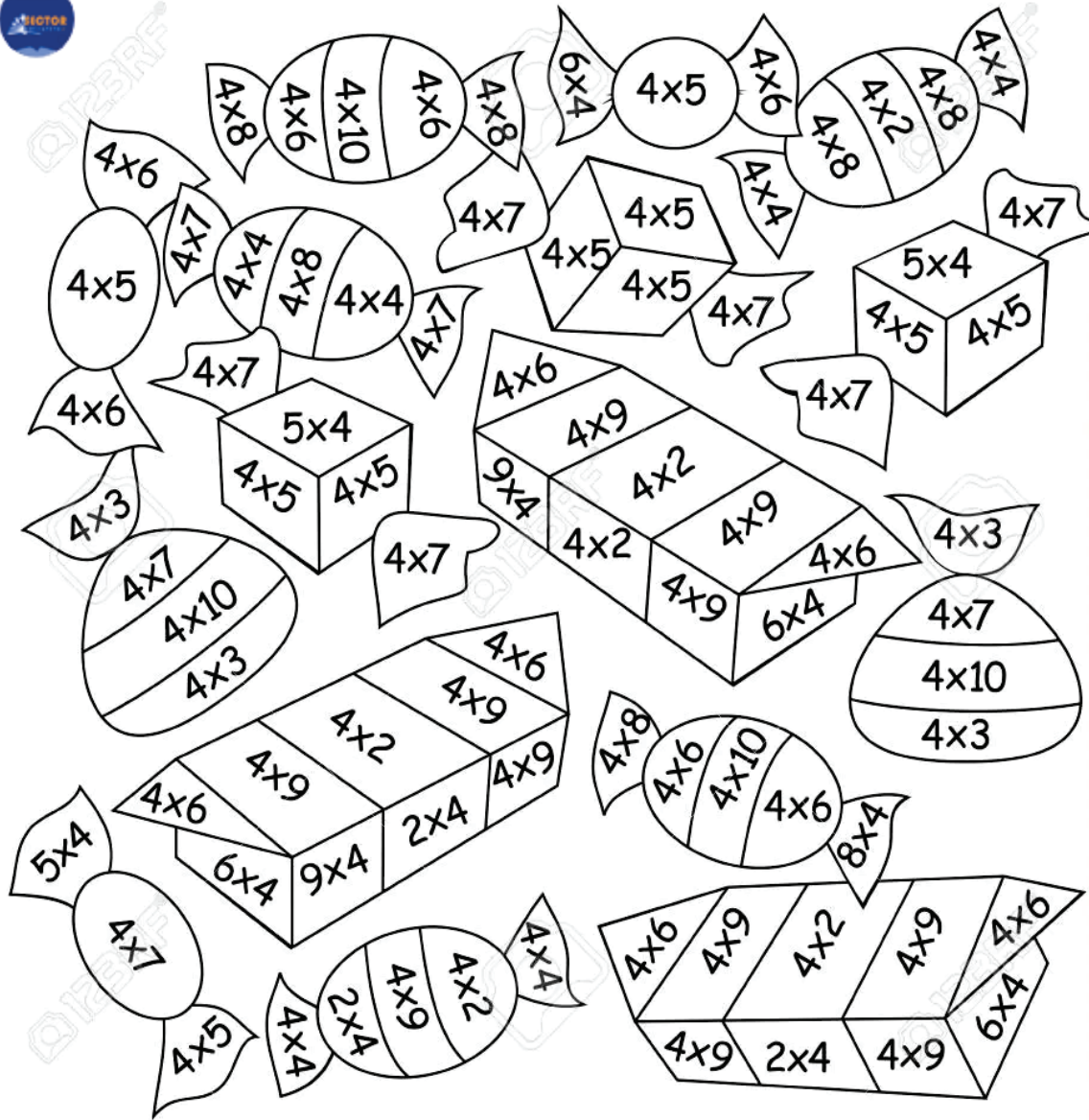

8 12 16 20 24 28 32 36 40

4X1=4  
4X2=8  
4X3=12  
4X4=16  
4X5=20  
4X6=24  
4X7=28  
4X8=32  
4X9=36  
4X10=40  
4X11=44  
4X12=48



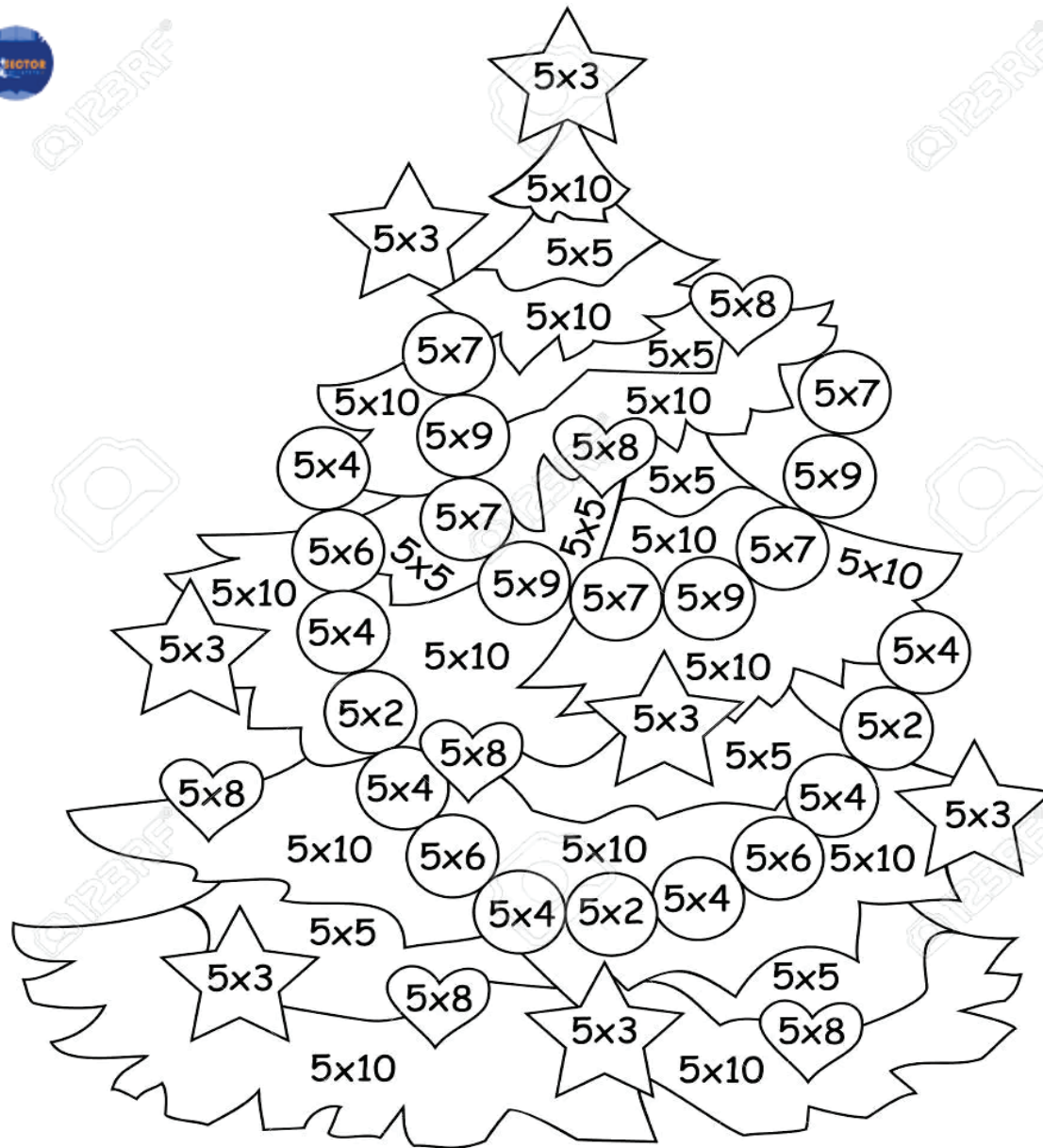

$5 \times 1 = 5$
$5 \times 2 = 10$
$5 \times 3 = 15$
$5 \times 4 = 20$
$5 \times 5 = 25$
$5 \times 6 = 30$
$5 \times 7 = 35$
$5 \times 8 = 40$
$5 \times 9 = 45$
$5 \times 10 = 50$
$5 \times 11 = 55$
$5 \times 12 = 60$

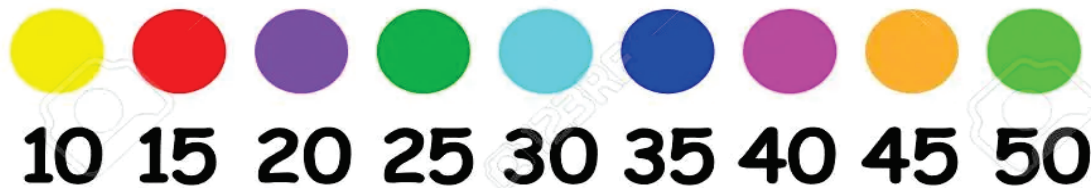

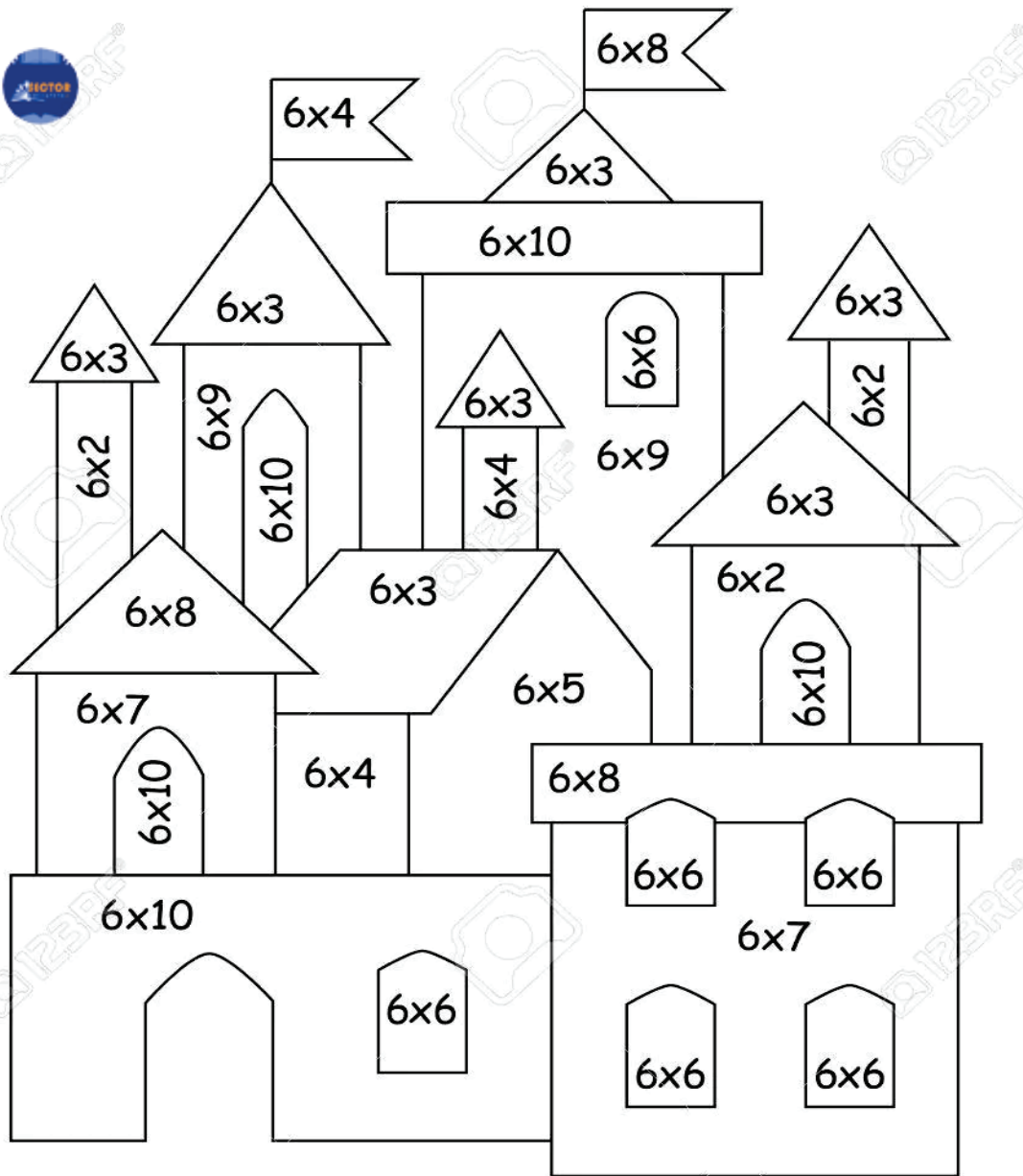

$$6 \times 1 = 6$$

$$6 \times 2 = 12$$

$$6 \times 3 = 18$$

$$6 \times 4 = 24$$

$$6 \times 5 = 30$$

$$6 \times 6 = 36$$

$$6 \times 7 = 42$$

$$6 \times 8 = 48$$

$$6 \times 9 = 54$$

$$6 \times 10 = 60$$

$$6 \times 11 = 66$$

$$6 \times 12 = 72$$



12

18

24

30

36

42

48

54

60

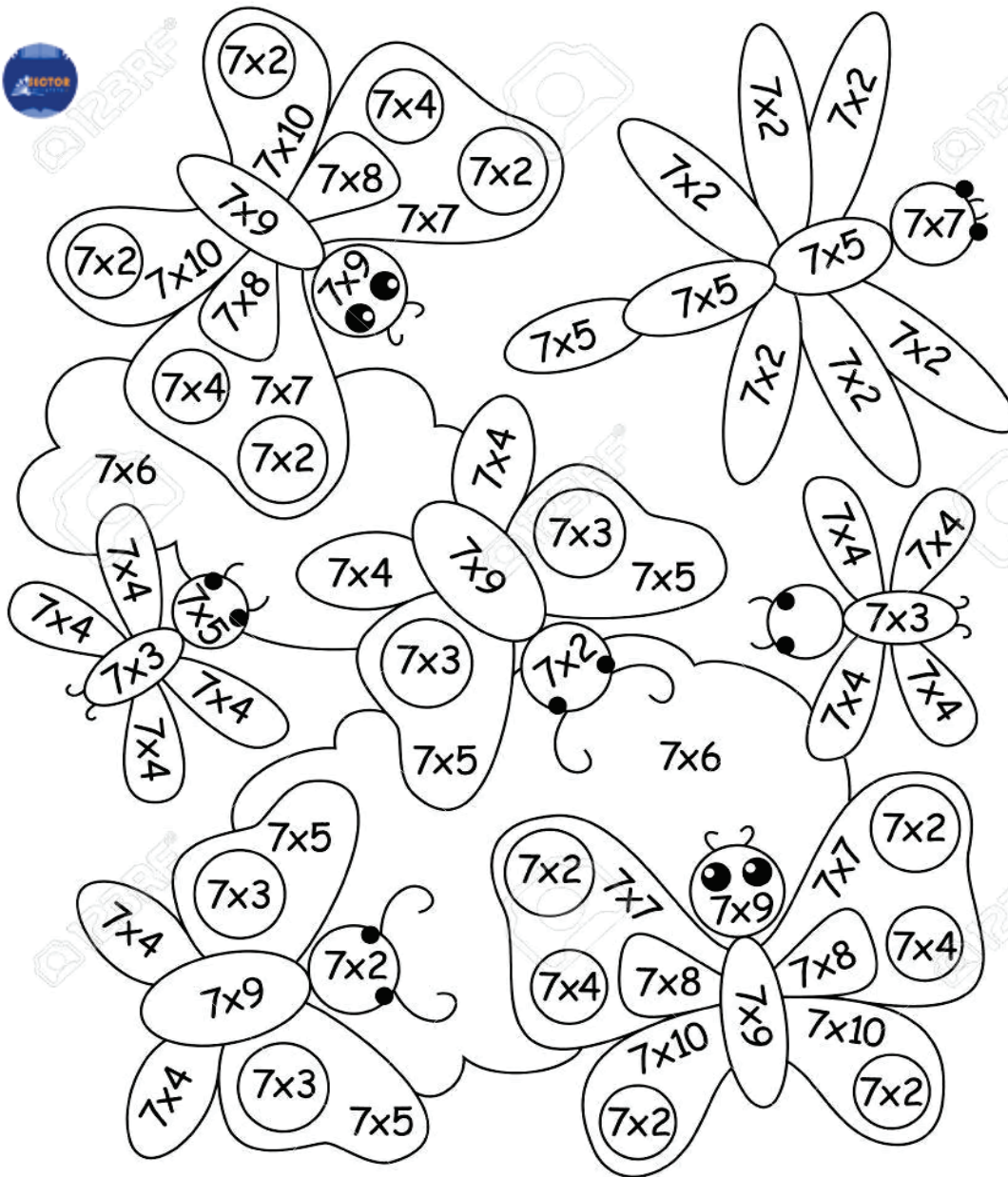

**7X1=7**  
**7X2=14**  
**7X3=21**  
**7X4=28**  
**7x5=35**  
**7X6=42**  
**7X7=49**  
**7x8=56**  
**7X9=63**  
**7X10=70**  
**7X11=77**  
**7X12=84**





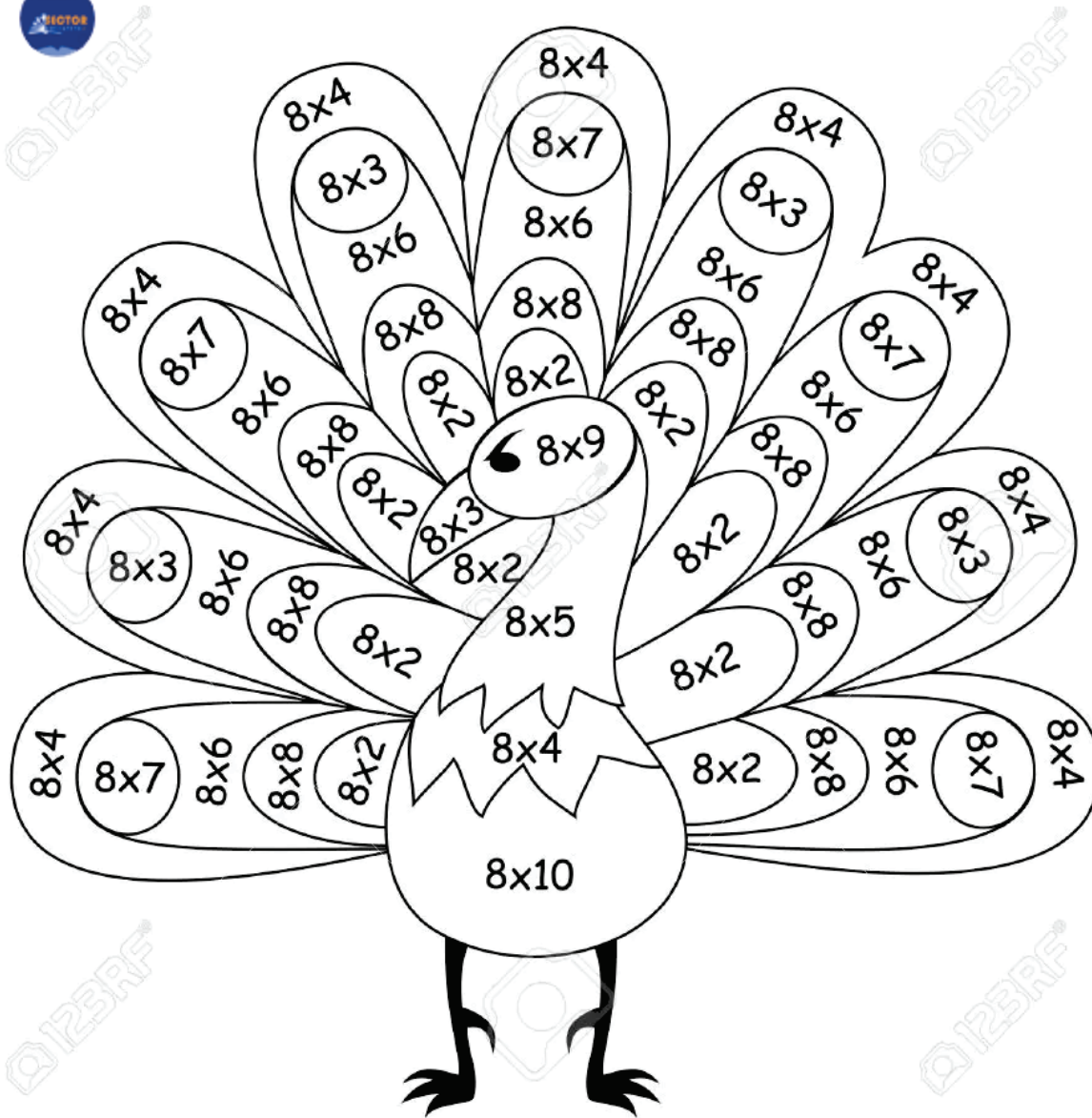

$$8 \times 1 = 8$$

$$8 \times 2 = 16$$

$$8 \times 3 = 24$$

$$8 \times 4 = 32$$

$$8 \times 5 = 40$$

$$8 \times 6 = 48$$

$$8 \times 7 = 56$$

$$8 \times 8 = 64$$

$$8 \times 9 = 72$$

$$8 \times 10 = 80$$

$$8 \times 11 = 88$$







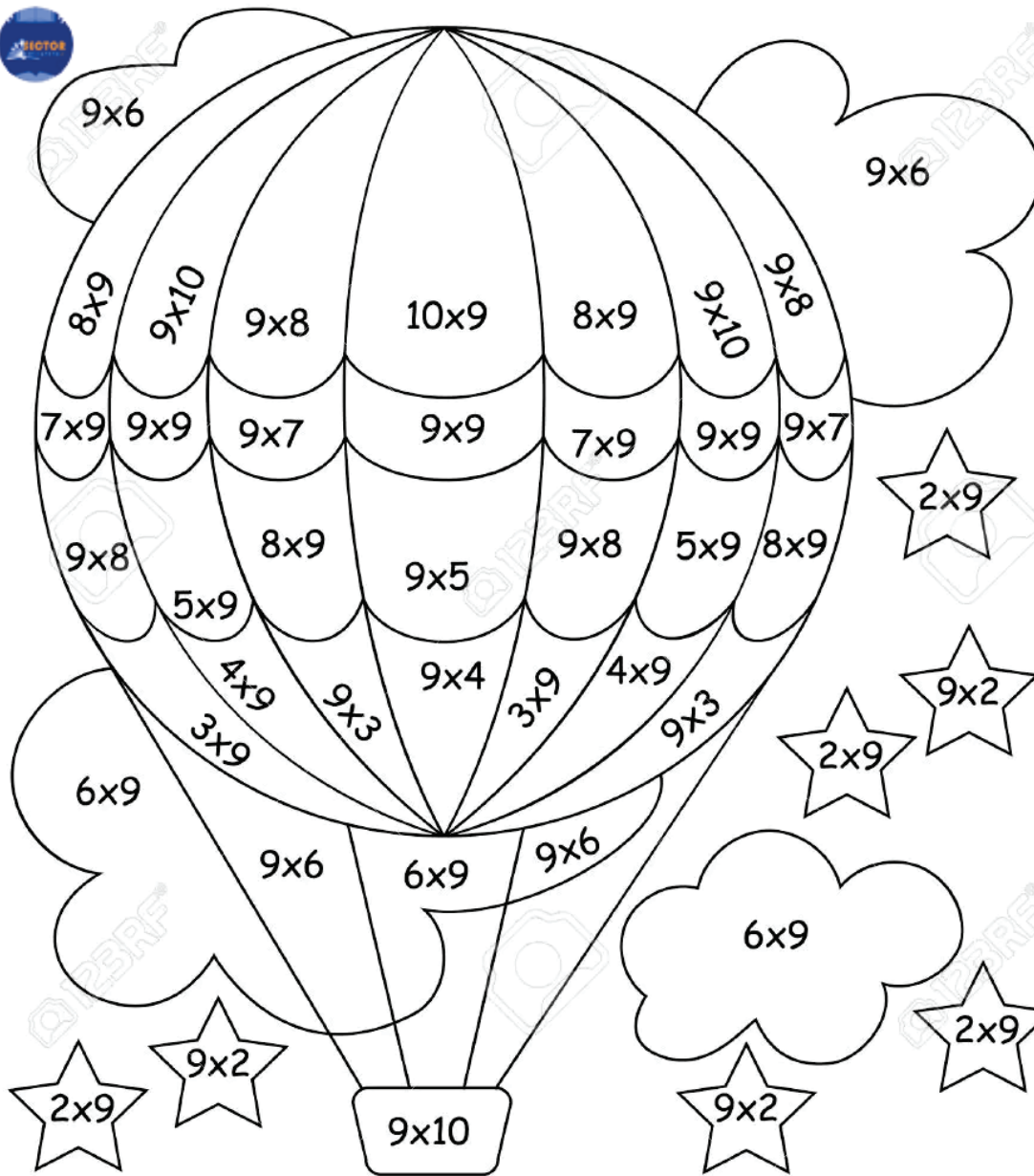

$$8 \times 12 = 96$$



16 24 32 40 48 56 64 72 80



<b>9X1=9</b>
<b>9X2=18</b>
<b>9X3=27</b>
<b>9X4=36</b>
<b>9x5=45</b>
<b>9X6=54</b>
<b>9X7=63</b>
<b>9x8=72</b>
<b>9X9=81</b>
<b>9X10=90</b>
<b>9X11=99</b>
<b>9X12=108</b>

								
<b>18</b>	<b>27</b>	<b>36</b>	<b>45</b>	<b>54</b>	<b>63</b>	<b>72</b>	<b>81</b>	<b>90</b>